



Bina cephesinde Projesine uygun olarak alüminyum ankrajlar, alüminyum düşey T Profiller ve özel kesitli yatay profillerden teşkil edilen taşıyıcı alt konstrüksiyon üzerine, Fibercement plakalar, arkalarına 4 noktadan tespit edilen agraflı klipsleri vasıtası asılır. Bu Sistemde Derzler Açıktır.



Fiber Cement / Agraflı Sistem Bileşenleri

ÜRÜN RESMİ	ÜRÜN KODU	ÜRÜN BİLGİSİ	RENK	AMBALAJ MİKTARI
	T43539	50 X 30 X 1,8mm TIRTIILLI T PROFİL	PRES / ELOKSAL / RAL.... Boyalı	6 METRE / ADET
	T43540	50 X 30 X 2mm TIRTIILLI T PROFİL	PRES / ELOKSAL / RAL.... Boyalı	6 METRE / ADET
	T43538	50 X 50 X 1,8mm TIRTIILLI T PROFİL	PRES / ELOKSAL / RAL.... Boyalı	6 METRE / ADET
	T43546	50 X 50 X 2mm TIRTIILLI T PROFİL	PRES / ELOKSAL / RAL.... Boyalı	6 METRE / ADET
	T43537	50 X 70 X 1,8mm TIRTIILLI T PROFİL	PRES / ELOKSAL / RAL.... Boyalı	6 METRE / ADET
	T43545	50 X 70 X 2mm TIRTIILLI T PROFİL	PRES / ELOKSAL / RAL.... Boyalı	6 METRE / ADET
	30138	25 X 50 X 1,7mm TIRTIILLI T PROFİL	PRES / ELOKSAL / RAL.... Boyalı	6 METRE / ADET
	30137	25 X 50 X 2mm TIRTIILLI T PROFİL	PRES / ELOKSAL / RAL.... Boyalı	6 METRE / ADET
	T43544	30 X 30 X 1,8mm TIRTIILLI T PROFİL	PRES / ELOKSAL / RAL.... Boyalı	6 METRE / ADET
	30146	KOMPAKT LAMİNAT YATAY PROFİLİ	PRES /SİYAH	6 METRE/ADET
	30145-50	KOMPAKT LAMİNAT ÜST KLİPS AYARLI	PRES	300 ADET/ÇUVAL
	30145-40	KOMPAKT LAMİNAT ALT KLİPS	PRES	300 ADET/ÇUVAL
	Hareketli Ankraj Tipleri için Tıklayın	ALÜMİNYUM ANKRAJ L TİPİ HAREKETLİ 50,70 ve 80 LİK (60,80,100,120,140,160 mm LİK BAYRAK UZUNLUKLARINDA)	PRES / ELOKSAL	PAKET / KOLİ
	Sabit Ankraj Tipleri için Tıklayın	ALÜMİNYUM ANKRAJ L TİPİ SABİT 100,120 ve 150 LİK (60,80,100,120,140,160 mm LİK BAYRAK UZUNLUKLARINDA)	PRES / ELOKSAL	PAKET / KOLİ
	M520AKB	M5 AYAR VİDASI	GALVANİZ / PASLANMAZ	PAKET / KOLİ
	YHB4825	YHB AYAR VİDASI	GALVANİZ	PAKET / KOLİ
	YSB6010	AGRAF VİDASI	GALVANİZ	PAKET / KOLİ
	AKB5525	AKB VİDA	ÇİNKO / GALVANİZ / İNOX	PAKET / KOLİ
	POPİN4816	4,8x16 GENİŞ KAFA POP PERÇİN	ALU-STEEL / ALU-INOX	PAKET / KOLİ
	POPAL4816	4,8x25 GENİŞ KAFA POP PERÇİN	ALU-STEEL / ALU-INOX	PAKET / KOLİ
	DBK1075	KLİPSLİ ÇELİK DÜBEL	ÇİNKO / GALVANİZ / İNOX	PAKET / KOLİ
	DBG1085	GÖMLEKLİ ÇELİK DÜBEL	ÇİNKO / GALVANİZ / İNOX	PAKET / KOLİ
	DTAPS100	TUĞLA DÜBELİ	PLASTİK / NYLON - ÇİNKO / GALVANİZ / İNOX	PAKET / KOLİ
	DYT06	YTONG TUĞLA DÜBELİ (6,8,10 cm UZUNLUKLARINDA)	PLASTİK / NYLON - ÇİNKO / GALVANİZ / İNOX	PAKET / KOLİ

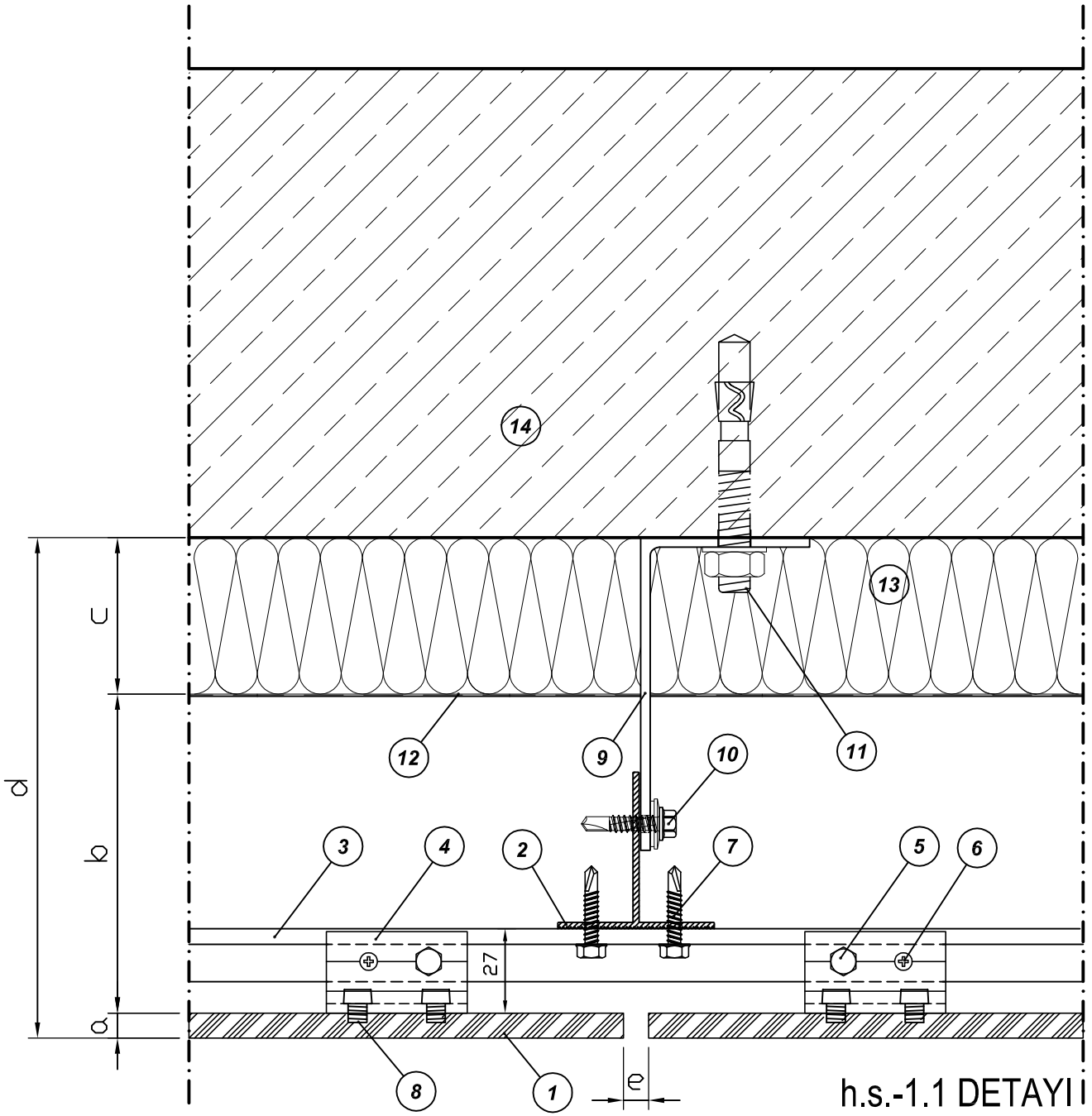

h.s.-1.1 DETAYI

ALÜSAN Detay Bileşenleri

- | | |
|--------------------------------------|-----------------------------|
| 1-Fiber Cement Paneli | 8- Agraf-Kompakt Vidası |
| 2- T Profil 50x50 | 9- Alüminyum Ankraj |
| 3-Fiber Cement Yatay Profili (30146) | 10-AKB M.U. Vida (5,5x25mm) |
| 4-Fiber Cement Klips (3014550) | 11-Çelik Dübel |
| 5-AKB M.U. Vida (5x20mm) | 12-Buhar Dengeleyici Örtü |
| 6-YHB M.U. Vida (4,8x25mm) | 13-Isı İzolasyon Malzemesi |
| 7- AKB M.U. Vida (5,5x25mm) | 14-Betonarme / Tuğla Duvar |

Toleranslar

- a-Panel Kalınlığı (8,10,12,14mm)
b-Hava Boşluğu (min 20mm, önerilen 50mm)
c-İzolasyon Kalınlığı (5,6,8,10cm)
d-Sistem Açıklığı (min.105mm)
e-Derz Boşluğu (4,5,6,7,8 mm)

Copyright © 2013 by Alü-san Alüminyum Sanayi ve Tic. A.Ş. Firmamız tarafından hazırlanmış olan yukarıdaki teknik çizim ve tanımlamalar kanunlarla koruma altına alınmıştır ve izinsiz kullanılamaz.

Pafta No:	Sistem : Fiber Cement Agrafılı Sistem
Ölçek : 1/2	Pafta Adı : Plan Detayı(h.s-1.1)
Tarih: 2019 / 03	
Çizen : B.S.A.	T: +90 0212 480 06 00 pbx F: +90 0212 480 06 11 pbx M: info@alusan.com.tr www.alusan.com.tr



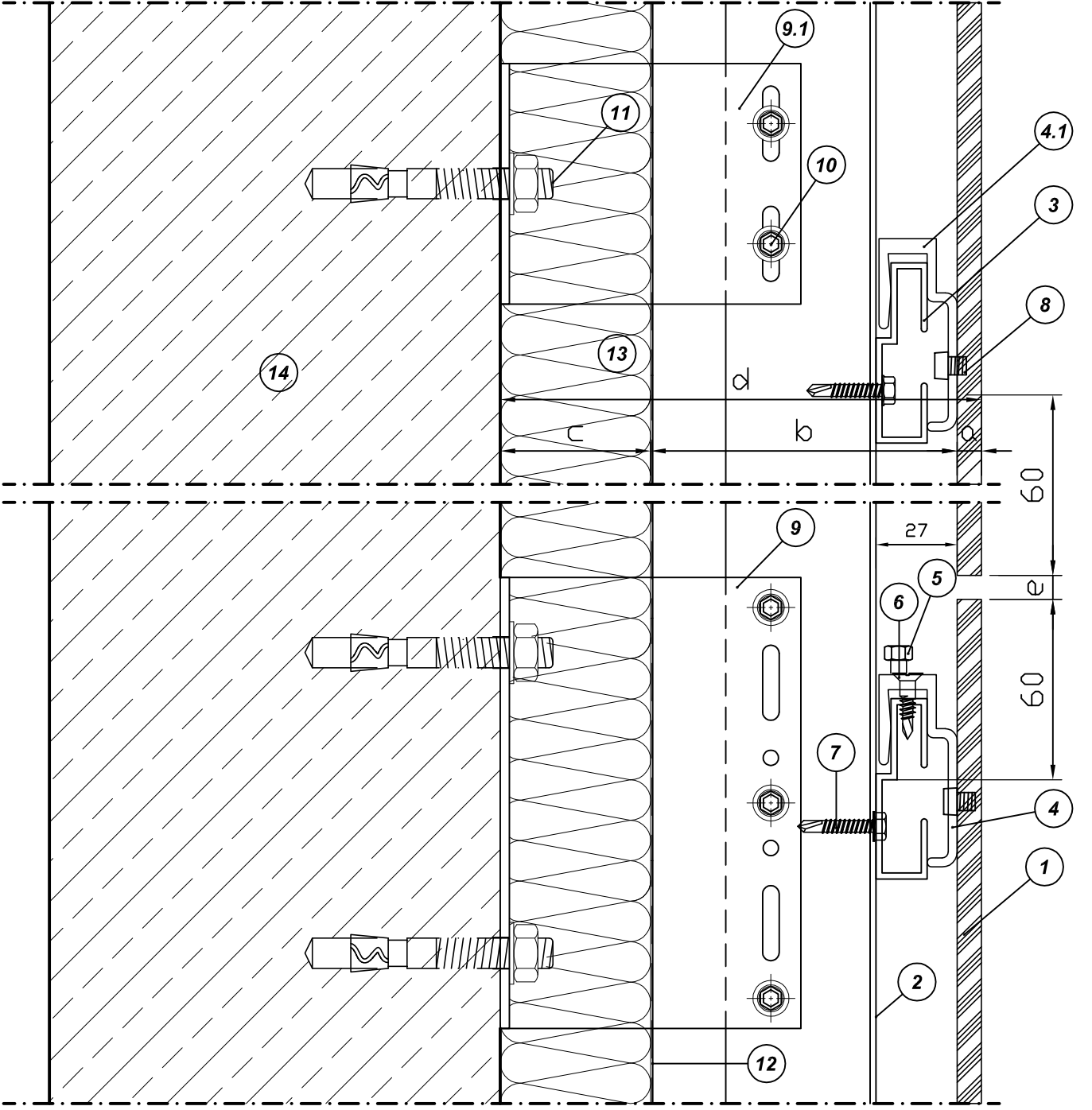

v.s.-1.1 DETAYI

ALÜSAN Detay Bileşenleri

1-Fiber Cement Paneli	8- Agraf-Kompakt Vidası
2- T Profil 50x50	9- 150x100 Alüminyum Ankrāj
3-Fiber Cement Yatay Profili (30146)	9.1- 80x100 Alüminyum Ankrāj
4-Fiber Cement Üst Klips (3014550)	10-AKB M.U. Vida (5,5x25mm)
4.1-Fiber Cement Alt Klips (3014540)	11-Çelik Dübel
5-AKB M.U. Vida (5x20mm)	12-Buhar Dengeleyici Örtü
6-YHB M.U. Vida (4,8x25mm)	13-Isı İzolasyon Malzemesi
7- AKB M.U. Vida (5,5x25mm)	14-Betonarme / Tuğla Duvar

Toleranslar

a-Panel Kalınlığı (8,10,12,14mm)
b-Hava Boşluğu (min 20mm, önerilen 50mm)
c-İzolasyon Kalınlığı (5,6,8,10cm)
d-Sistem Açıklığı (min.105mm)
e-Derz Boşluğu (4,5,6,7,8 mm)

Copyright © 2013 by Alü-san Alüminyum Sanayi ve Tic. A.Ş. Firmamız tarafından hazırlanmış olan yukarıdaki teknik çizim ve tanımlamalar kanunlarla koruma altına alınmıştır ve izinsiz kullanılamaz.

Pafta No:	Sistem : Fiber Cement Agrafli Sistem
Ölçek : 1/2	Pafta Adı : Kesit Detayı(v.s-1.1)
Tarih: 2019 / 03	
Çizen : B.S.A.	T: +90 0212 480 06 00 pbx F: +90 0212 480 06 11 pbx M: info@alusan.com.tr www.alusan.com.tr





No:10127
Köşe Profili
max 11mm seramik

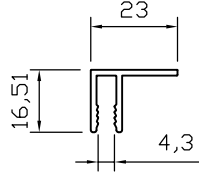

No: 36917
F Profili 23x16,5

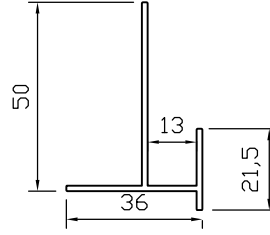

No: Y43381
Damlalık Profili

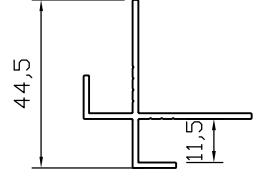

No: Y39422
Köşe Profili

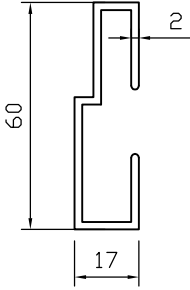

No: 30146
Fiber Cement Yatay Profili

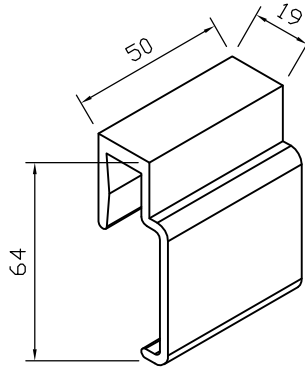

No: 3014550
Fiber Cement Üst Klips

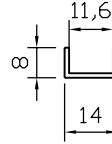

No: Y39231
U Profili

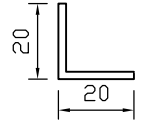

No: 1107
20x20 L Profil



Agraf-Kompakt vidası



4,8x25 YhHB. MU. Vida

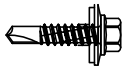

5,5x25 AKB M.U. Vida

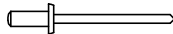

4x10 Pop Perçin

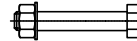

M5x30 Civata, Somun, Pul

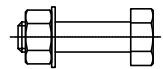

M8x30 Civata, Somun, Pul



3,9x19 YhHB. MU. Vida

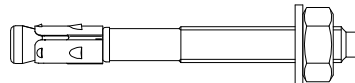

M10x90 Klipsli Dübel

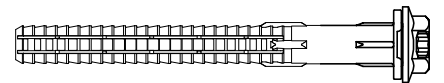

M10x100 Tuğla Dübeli Takımı

