



Alüminyum ankrajlar ve Düşey Taşıyıcı T Profillerden teşkil edilen alt konstrüksiyon üzerine Seramikler yerine göre 4 lü veya 2 li ara ve alt Paslanmaz klipsler ile birlikte Taşıyıcı profillere sabitlenir. Klipslerde bulunan epdm fitiller, seramiğin profile direk temasını engeller ve klipslere iyi bir şekilde oturmasını sağlar. Paslanmaz Klipsler Ral Renginde boyatılabilir. Ekonomik uygulaması hızlı ve güvenli bir sistemdir.



# Seramik Cephe / 4'lü Klipsli Sistem Bileşenleri

ÜRÜN RESMİ	ÜRÜN KODU	ÜRÜN BİLGİSİ	RENK	AMBALAJ MİKTARI
	T43539	50 X 30 X 1,8mm TIRTIILLI T PROFİL	PRES / ELOKSAL / RAL.... Boyalı	6 METRE / ADET
	T43540	50 X 30 X 2mm TIRTIILLI T PROFİL	PRES / ELOKSAL / RAL.... Boyalı	6 METRE / ADET
	T43538	50 X 50 X 1,8mm TIRTIILLI T PROFİL	PRES / ELOKSAL / RAL.... Boyalı	6 METRE / ADET
	T43546	50 X 50 X 2mm TIRTIILLI T PROFİL	PRES / ELOKSAL / RAL.... Boyalı	6 METRE / ADET
	T43537	50 X 70 X 1,8mm TIRTIILLI T PROFİL	PRES / ELOKSAL / RAL.... Boyalı	6 METRE / ADET
	T43545	50 X 70 X 2mm TIRTIILLI T PROFİL	PRES / ELOKSAL / RAL.... Boyalı	6 METRE / ADET
	30138	25 X 50 X 1,7mm TIRTIILLI T PROFİL	PRES / ELOKSAL / RAL.... Boyalı	6 METRE / ADET
	30137	25 X 50 X 2mm TIRTIILLI T PROFİL	PRES / ELOKSAL / RAL.... Boyalı	6 METRE / ADET
	T43544	30 X 30 X 1,8mm TIRTIILLI T PROFİL	PRES / ELOKSAL / RAL.... Boyalı	6 METRE / ADET
	K513H4	K5 4' LÜ ARA KLİPS 13MM HAM	NATUREL / RAL RENGİ	PAKET / KOLİ
	K613H2	K6 2' Lİ ALT KLİPS 13MM HAM	NATUREL / RAL RENGİ	PAKET / KOLİ
	K513H2	K5 2' Lİ ARA KLİPS 13MM HAM	NATUREL / RAL RENGİ	PAKET / KOLİ
	K613H1	K6 TEKLİ ALT KLİPS 13MM HAM	NATUREL / SİYAH	PAKET / KOLİ
	10125	KÖŞE DÖNÜŞ PROFİLİ	PRES / ELOKSAL / RAL.... Boyalı	6 METRE / ADET
	10126	KÖŞE DÖNÜŞ PROFİLİ	PRES / ELOKSAL / RAL.... Boyalı	6 METRE / ADET
	39422	TIRNAKLI KÖŞE DÖNÜŞ PROFİLİ	PRES / ELOKSAL / RAL.... Boyalı	6 METRE / ADET
	EPİL7011	EPDM FİTİL 4'LÜ KLİPS SİSTEM 11MM	SİYAH	PAKET / KOLİ
	Hareketli Ankraj Tipleri için Tıklayın	ALÜMİNYUM ANKRAJ L TİPİ HAREKETLİ 50,70 ve 80 LİK (60,80,100,120,140,160 mm LİK BAYRAK UZUNLUKLARINDA)	PRES / ELOKSAL	PAKET / KOLİ
	Sabit Ankraj Tipleri için Tıklayın	ALÜMİNYUM ANKRAJ L TİPİ HAREKETLİ 50,70 ve 80 LİK (60,80,100,120,140,160 mm LİK BAYRAK UZUNLUKLARINDA)	PRES / ELOKSAL	PAKET / KOLİ
	AKB5525	AKB VİDA	ÇİNKO / GALVANİZ / İNOX	PAKET / KOLİ
	POPAL4010	4x10 ALÜMİNYUM POP PERÇİN	ALU-STEEL / ALU-İNOX	PAKET / KOLİ
	POPİN4816	4,8x16 GENİŞ KAFA POP PERÇİN	ALU-STEEL / ALU-İNOX	PAKET / KOLİ
	POPAL4816	4,8x25 GENİŞ KAFA POP PERÇİN	ALU-STEEL / ALU-İNOX	PAKET / KOLİ
	DBK1075	KLİPSLİ ÇELİK DÜBEL	ÇİNKO / GALVANİZ / İNOX	PAKET / KOLİ
	DBG1085	GÖMLEKLİ ÇELİK DÜBEL	ÇİNKO / GALVANİZ / İNOX	PAKET / KOLİ
	DTAPS100	TUĞLA DÜBELİ	PLASTİK / NYLON - ÇİNKO / GALVANİZ / İNOX	PAKET / KOLİ
	DYT06	YTONG TUĞLA DÜBELİ (6,8,10 cm UZUNLUKLARINDA)	PLASTİK / NYLON - ÇİNKO / GALVANİZ / İNOX	PAKET / KOLİ

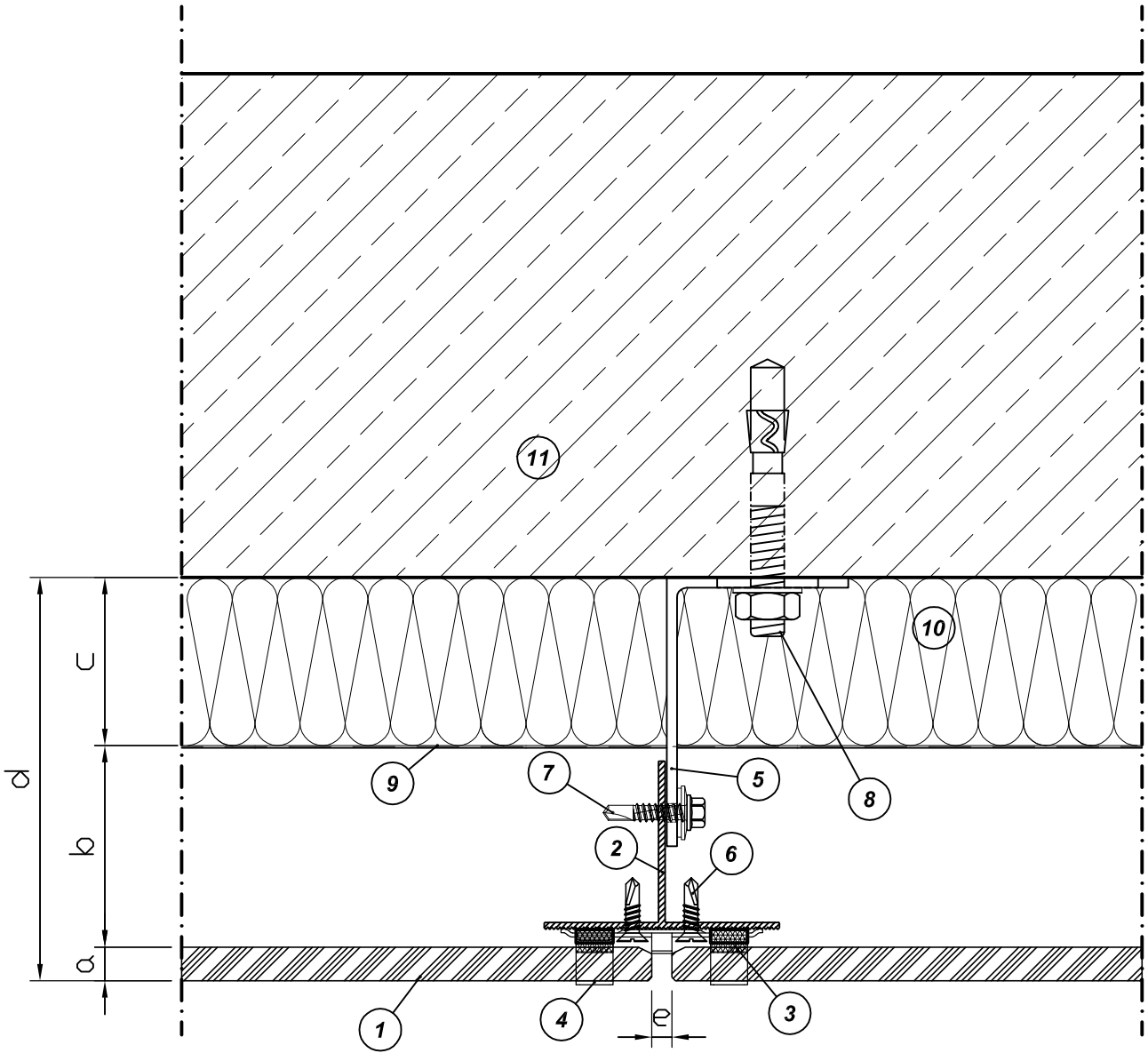

h.s.-1.1 DETAYI

### Sistem Detay Birleşenleri

- |                              |                            |
|------------------------------|----------------------------|
| 1-Porselen Seramik Paneli    | 7-AKB M.U. Vida (5,5x25mm) |
| 2- T Profil 50x70            | 8-Çelik Dübel              |
| 3-EPIL7011 Fitol             | 9-Buhar Dengeleyici Örtü   |
| 4- K5 4'lü Araklips (K513R4) | 10-Isı İzolasyon Malzemesi |
| 5-Alüminyum Ankrāj           | 11-Betonarme / Tuğla Duvar |
| 6-YHB M.U. Vida (3,9x16)     |                            |

### Toleranslar

- |  |
|--|
| a-Panel Kalınlığı (8-12mm)               |
| b-Hava Boşluğu (min 20mm, önerilen 50mm) |
| c-İzolasyon Kalınlığı (5-10cm)           |
| d-Sistem Açıklığı (min.80mm)             |
| e-Derz Boşluğu (6-8 mm)                  |

Copyright © 2013 by Alü-san Alüminyum Sanayi ve Tic. A.Ş. Firmamız tarafından hazırlanmış olan yukarıdaki teknik çizim ve tanımlamalar kanunlarla koruma altına alınmıştır ve izinsiz kullanılamaz.

Pafta No:	Sistem : <b>Seramik Cephe 4'lü Klipsli Sistem</b>
Ölçek : 1/2	Pafta Adı : <b>Plan Detayı(h.s-1.1)</b>
Tarih: 2019 / 03	
Çizen : E.GÜLER	T: +90 0212 480 06 00 pbx F: +90 0212 480 06 11 pbx M: info@alusan.com.tr www.alusan.com.tr



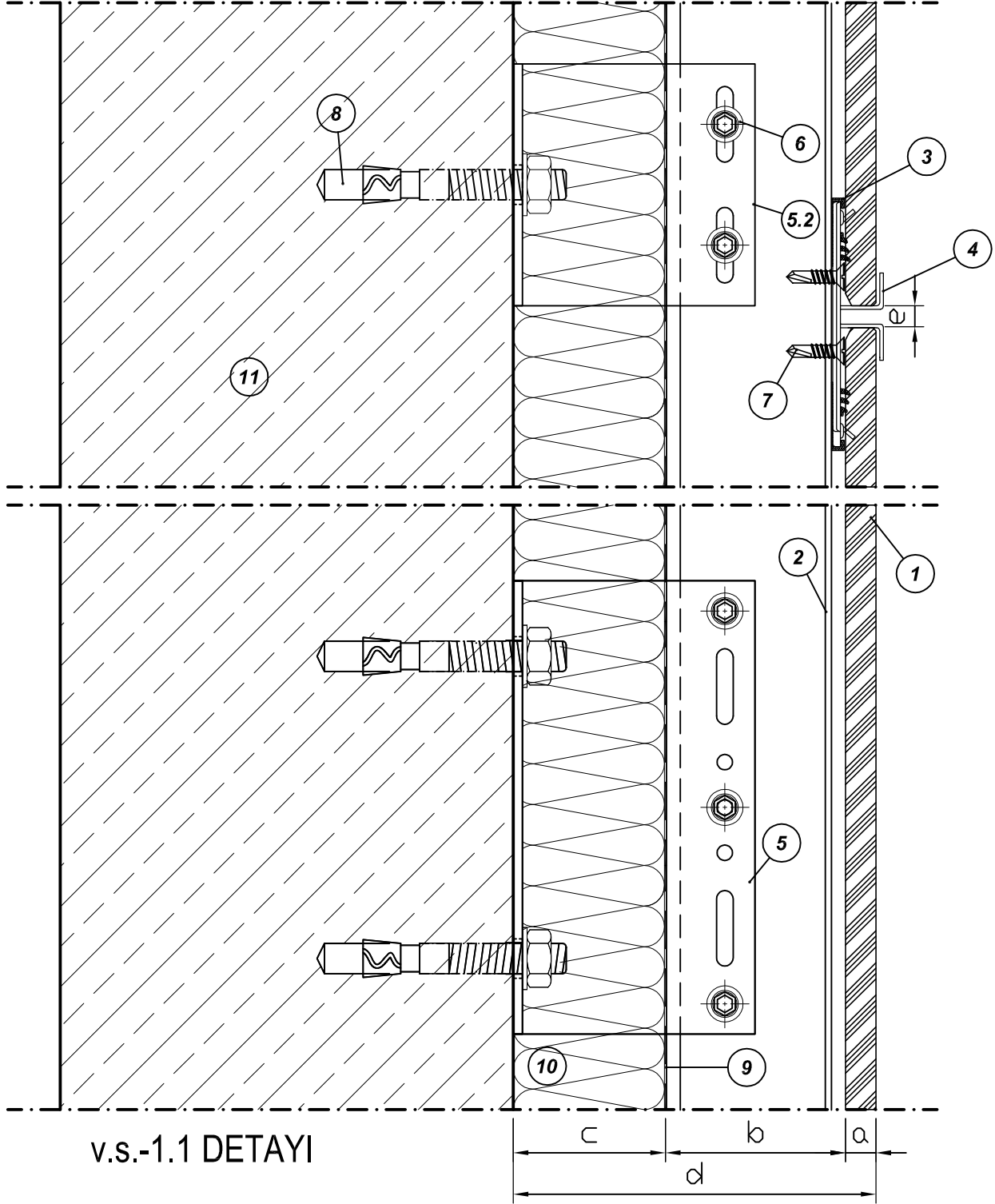

v.s.-1.1 DETAYI

### Sistem Detay Birleşenleri

- |                                      |                            |
|--------------------------------------|----------------------------|
| 1-Porselen Seramik Paneli            | 6-AKB M.U. Vida (5,5x25mm) |
| 2- T Profil - 50x70                  | 7-YHB M.U. Vida (3,9x16 )  |
| 3-EPIL7011 Fıtil                     | 8-Çelik Dübel              |
| 4- K5 4'lü Araklips (K513R4 )        | 9-Buhar Dengeleyici Örtü   |
| 5-150x80 Alüminyum Ankraj (29942150) | 10-Isı İzolasyon Malzemesi |
| 5.1-80x80 Alüminyum Ankraj (2994280) | 11-Betonarme / Tuğla Duvar |

### Toleranslar

- |   |
|---|
| a-Panel Kalınlığı ( 8-12mm )              |
| b-Hava Boşluğu (min 20mm, önerilen 50mm ) |
| c-İzolasyon Kalınlığı (5-10cm)            |
| d-Sistem Açıklığı (min.80mm )             |
| e-Derz Boşluğu (7 mm)                     |

Copyright © 2013 by Alü-san Alüminyum Sanayi ve Tic. A.Ş. Firmamız tarafından hazırlanmış olan yukarıdaki teknik çizim ve tanımlamalar kanunlarla koruma altına alınmıştır ve izinsiz kullanılamaz.

Pafta No:	Sistem :	<b>Seramik Cephe 4'lü Klipsli Sistem</b>
Ölçek : 1/2	Pafta Adı :	<b>Kesit Detayı(v.s-1.1)</b>
Tarih: 2019 / 03		
Çizen : E.GÜLER	T: +90 0212 480 06 00 pbx F: +90 0212 480 06 11 pbx M: info@alusan.com.tr www.alusan.com.tr	



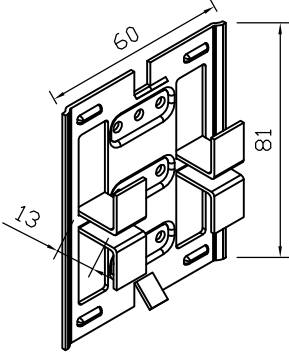

No: K513R4  
K5 4'lü Araklips  
Ral Boyalı Paslanmaz Çelik

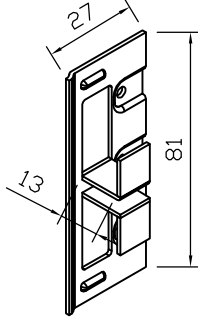

No: K513R2  
K5 2'li Araklips  
Ral Boyalı Paslanmaz Çelik

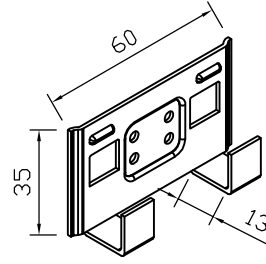

No: K613R2  
K5 2'li Araklips  
Ral Boyalı Paslanmaz Çelik

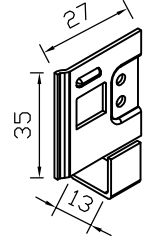

No: K613R1  
K5 Tekli Araklips  
Ral Boyalı Paslanmaz Çelik

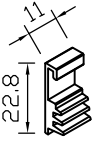

No: EPİL 7011  
4lü Klips Kitili

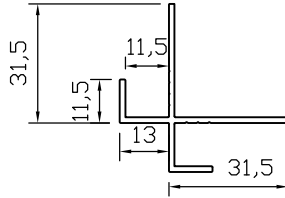

No: 39422  
Köşe Profili

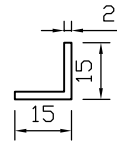

No: 1104  
Lento "L" Profili

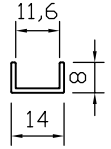

No: 39231  
U Profili

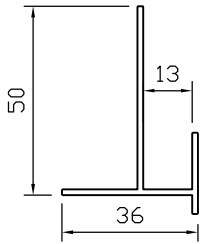

No: Y43381  
Damlalık Profili

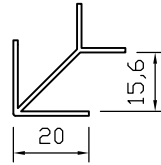

No: 10127  
Köşe Profili

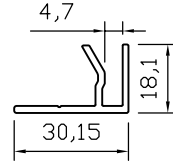

No: 39882  
F Profili 30x18

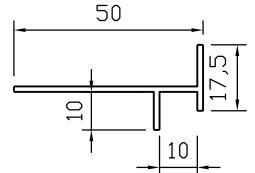

No: Y41047  
Damlalık Profili

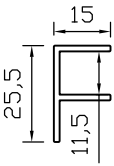

No: T38875  
Seramik F Profili

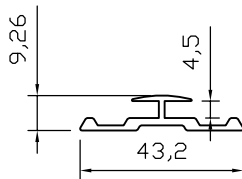

No: 38193  
Kompozit H Profili 43x9,3

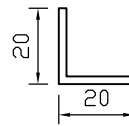

No: 1107  
20x20 L Profil

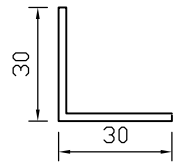

No: 1112  
30x30 L Profil

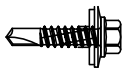

5,5x25 AKB M.U. Vida

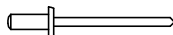

4x10 Pop Perçin

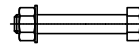

M5x30 Civata, Somun, Pul



M8x30 Civata, Somun, Pul



3,9x19 YhHB. MU. Vida

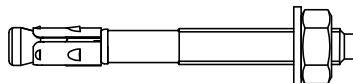

M10x90 Klipsli Dübel

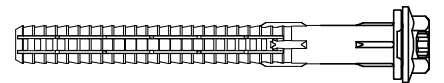

M10x100 Tuğla Dübeli Takımı

